

Vision & Robotics 2023

Extremely large telescope

Ramon Navarro
Manager Optical & Infrared
Telescopes & Instrumentation





UNIVERSITEIT VAN AMSTERDAM



Netherlands Institute for Space Research



Universiteit Leiden



Netherlands Space Office

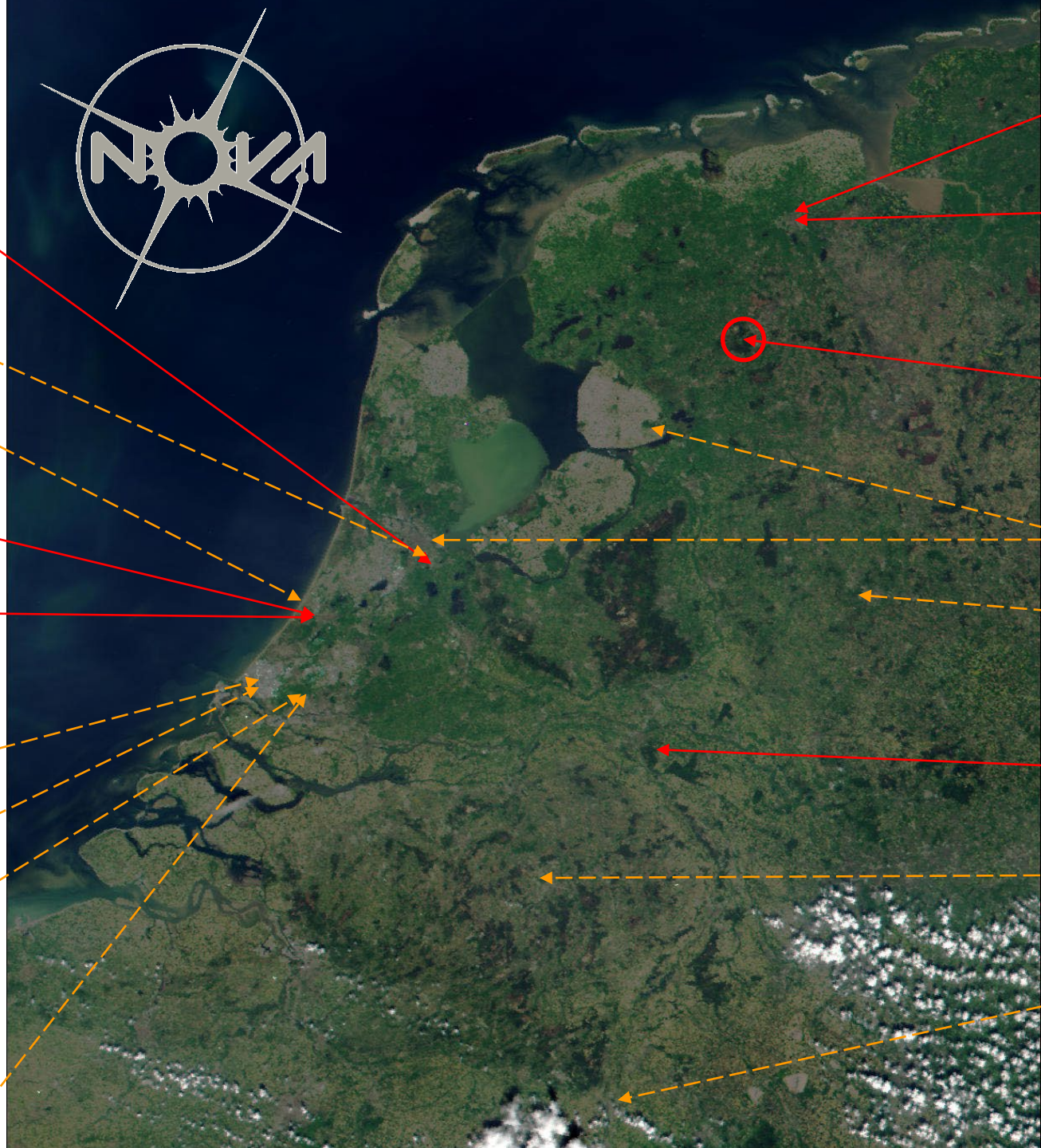

rijksuniversiteit groningen



Netherlands Institute for Space Research

NOVA Sub-mm



Netherlands Institute for Radio Astronomy

NOVA Optical InfraRed



UNIVERSITY OF TWENTE.



TU/e



Maastricht University



ADVANTECH

VWR
part of avantor

BOOM
SINCE 1893
MR. T. LABORATORIUMLEVERANCIER

van Asperen
KLEEFSTOFFEN

Mefion
Instrumentmakerij

fisher scientific
part of Thermo Fisher Scientific



Sheet Metal
OPTICON

wts

AUDION

PHILIPS

DESTACO

DELTA
ELEKTRONIKA
DC POWER SUPPLIES

Fraunhofer
IOF

VACUUM TECHNOLOGY
Hositrad

C&W
SNIJTECHNIEK
Maakt het met water

anteryon

MAG45
industrial supply solutions
VIRO

Landes
HIGH END MACHINING

AC
Astro Controls

alimex
PRECISION IN ALUMINIUM



ASTRON

Netherlands Institute for Radio Astronomy

SRON

Netherlands Institute for Space Research

esa

European Space Agency



smiths medical

knürr
environments for electronics

AIRBUS
DEFENCE & SPACE

de koningh
advanced
technology

hoek loos

FARNELL
in one

Lasaulec
TECHNISCHE GROOTHANDEL

NEWPORT

Hoffmann
Group

vossebelt

GANYMEDES
OPTISCHE INSTRUMENTEN

Jeveka

th
ASTROTEC HOLDING
SALDOLEC HOBBING

VS
VACUUM SPECIALS

HEC
HOLLAND
ENGINEERING
CONSULTANTS

SECO

De Groot
INSTALLATIEGROEP

UTI

Forwarding

IEST

AmEuro

Manutan
overtoom

Meproff

ANALYTICAL
SOLUTIONS
The Quality People

RADIOMETER

ENGELS
serving logistics and the environment

INDUCOMP
Oplossingen met Aluminium Profielen.

wildkamp

Linde

NEFAB

MCA Molenberg
mechatronica & aandrijftechniek

HAZENBERG
HASENBERG

RS
Components

micronclean

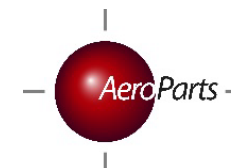

MAVOM
SPECIALTY CHEMICALS

HEGIN
metalfinishing

BIG science.nl
FOR BUSINESS

molenaar optics
industrial laser systems, measuring instruments, optical components

Agilent
Technologies

ets
european
test
services

SALOMON'S
METALLEN B.V.

WASP-39b with JWST NIRSpec PRISM

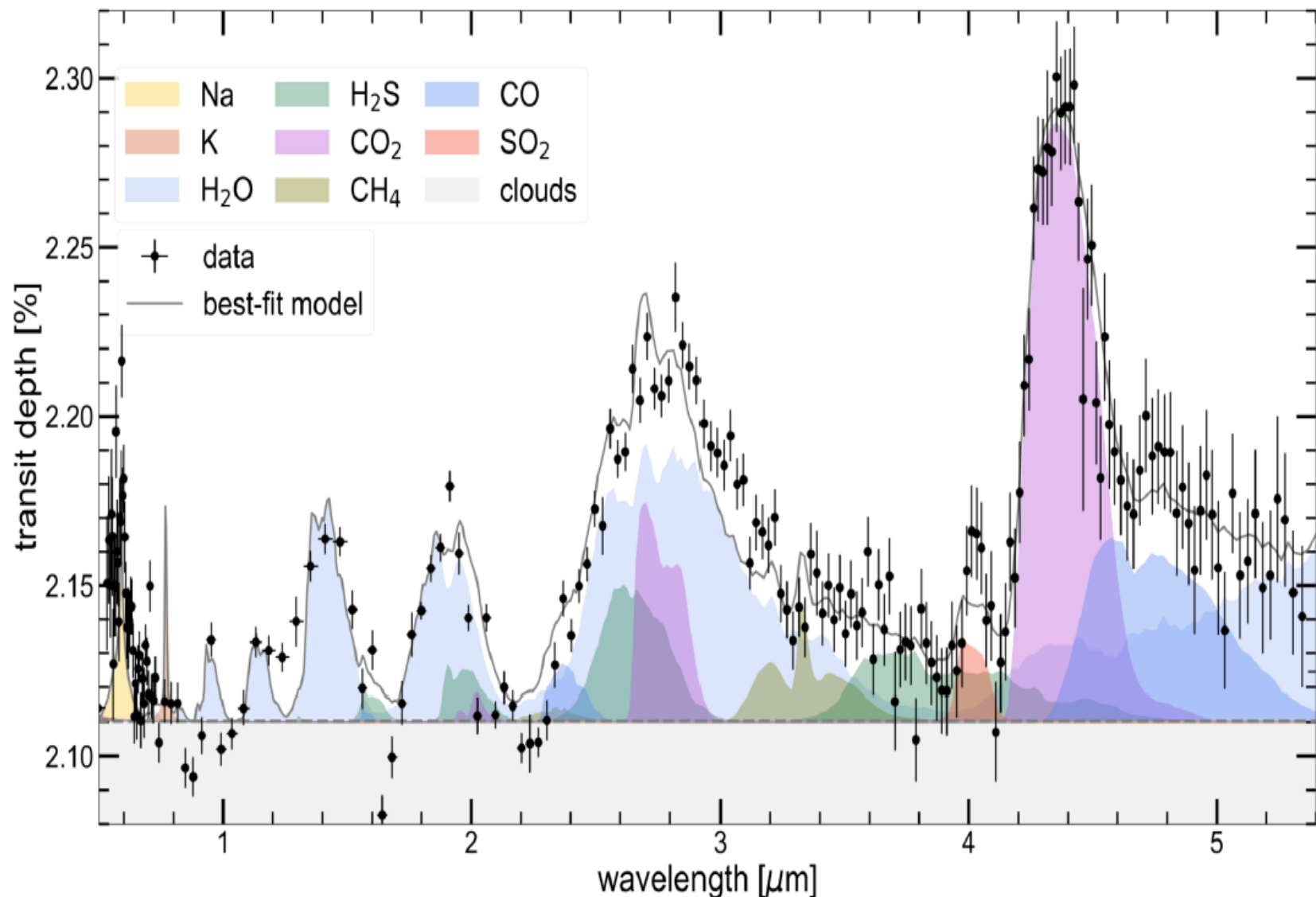
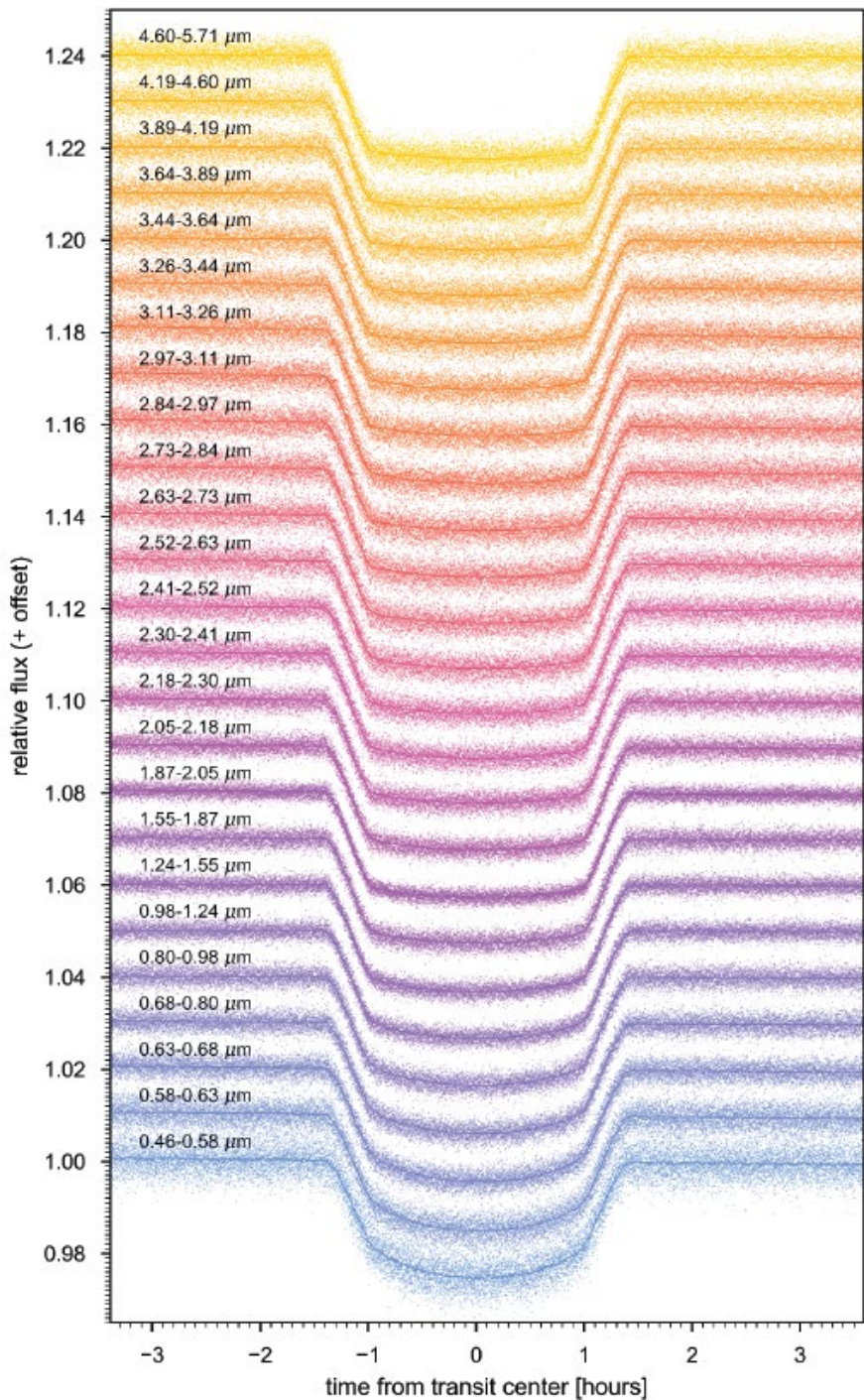

**James Webb
Space Telescope
MIRI
Mid InfraRed Instrument**







VLT-I MATISSE



ASTRON

VLT-I MATISSE

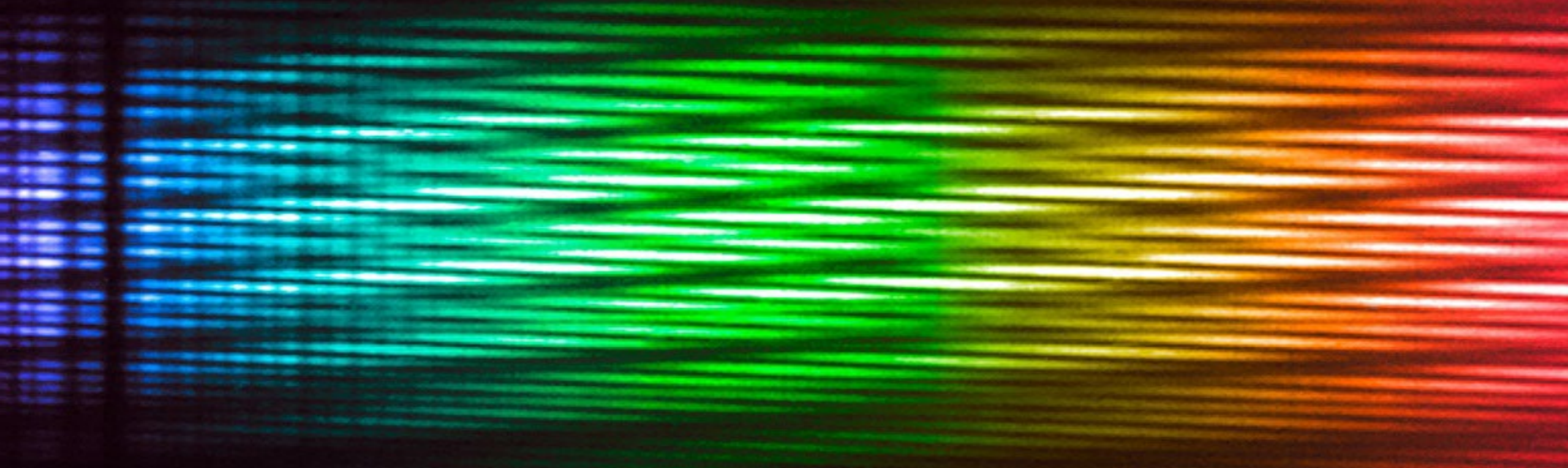

Extremely Large Telescope

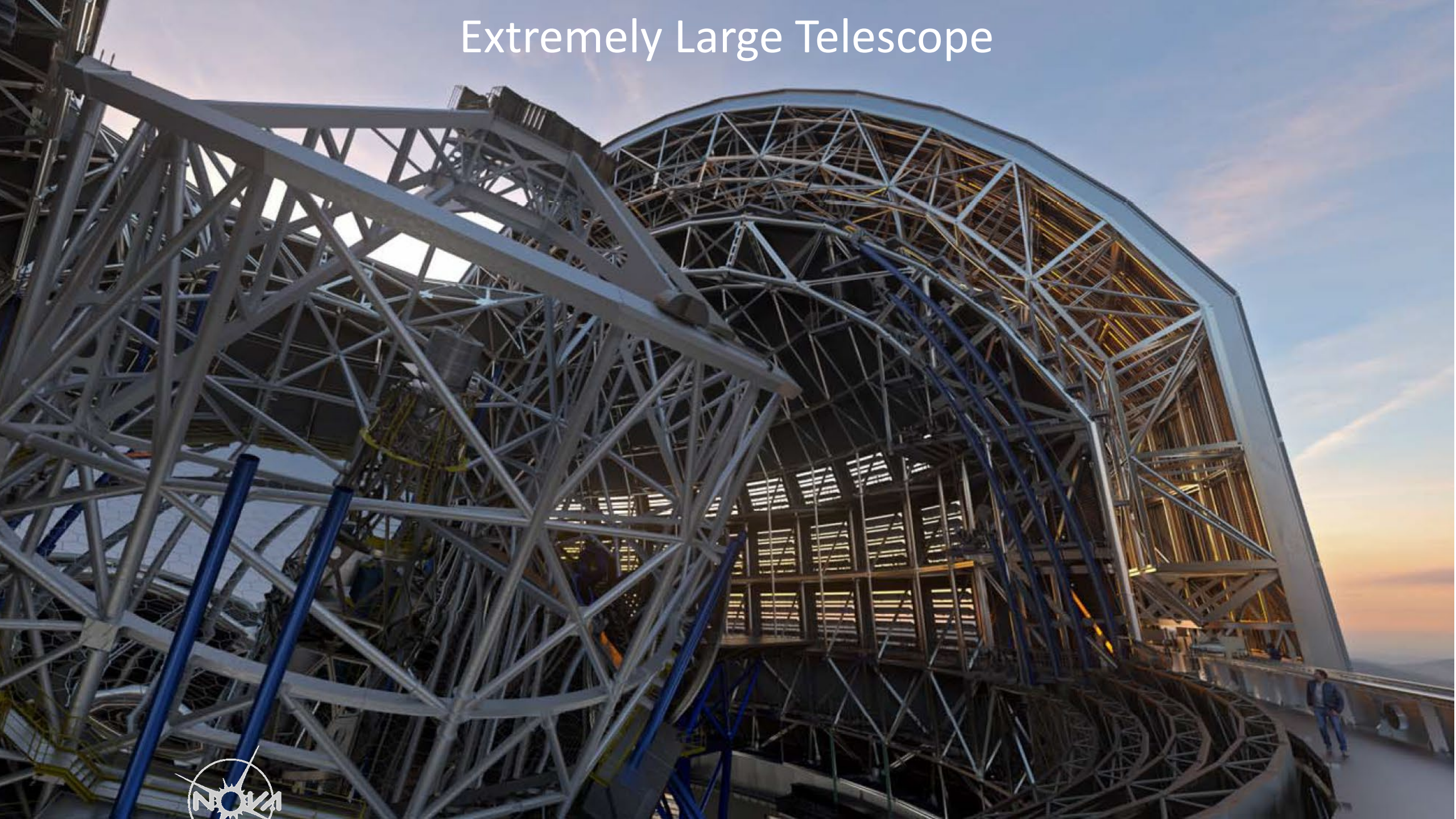

Extremely Large Telescope



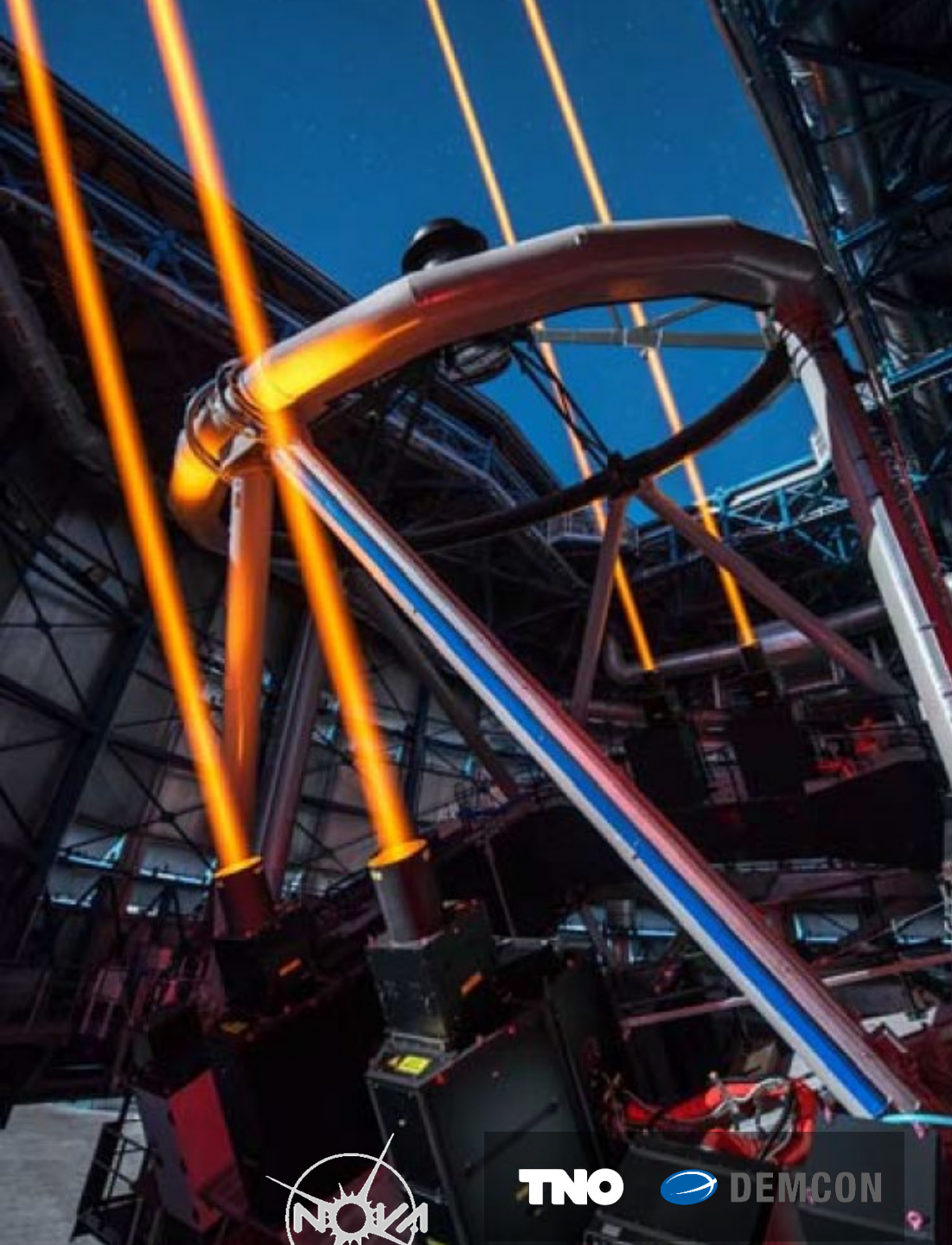

TNO DEMCON

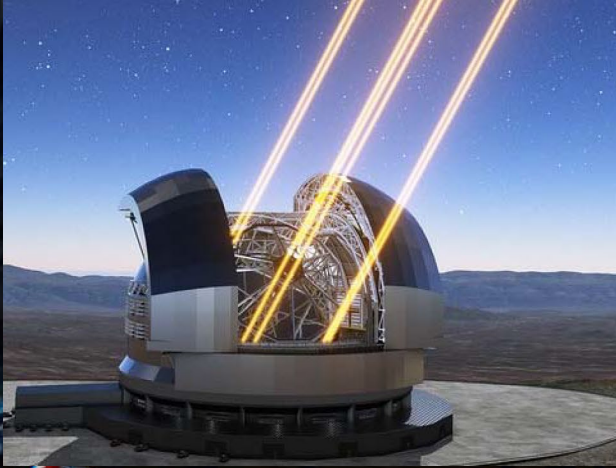

BIG science.nl
FOR BUSINESS



VBL

SEGMENT SUPPORT SIDE

MAX. 250 KG

Netherlands Instrumentation for the European Extremely Large Telescope (NL-ELT)

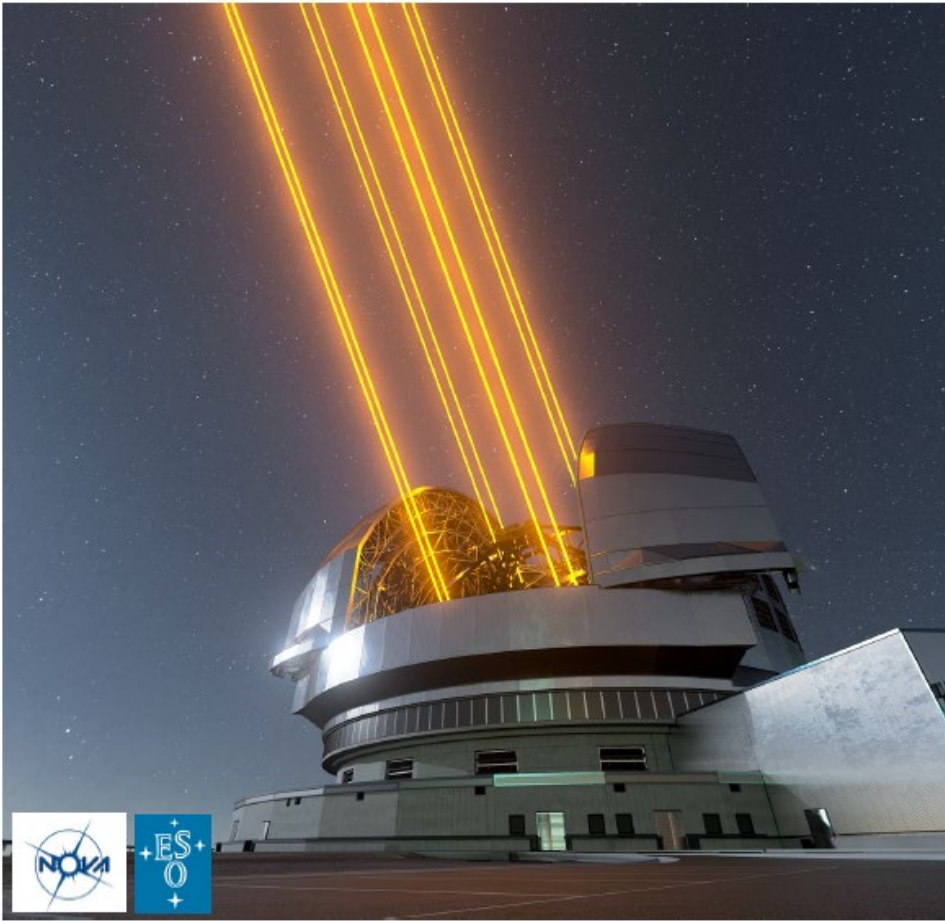
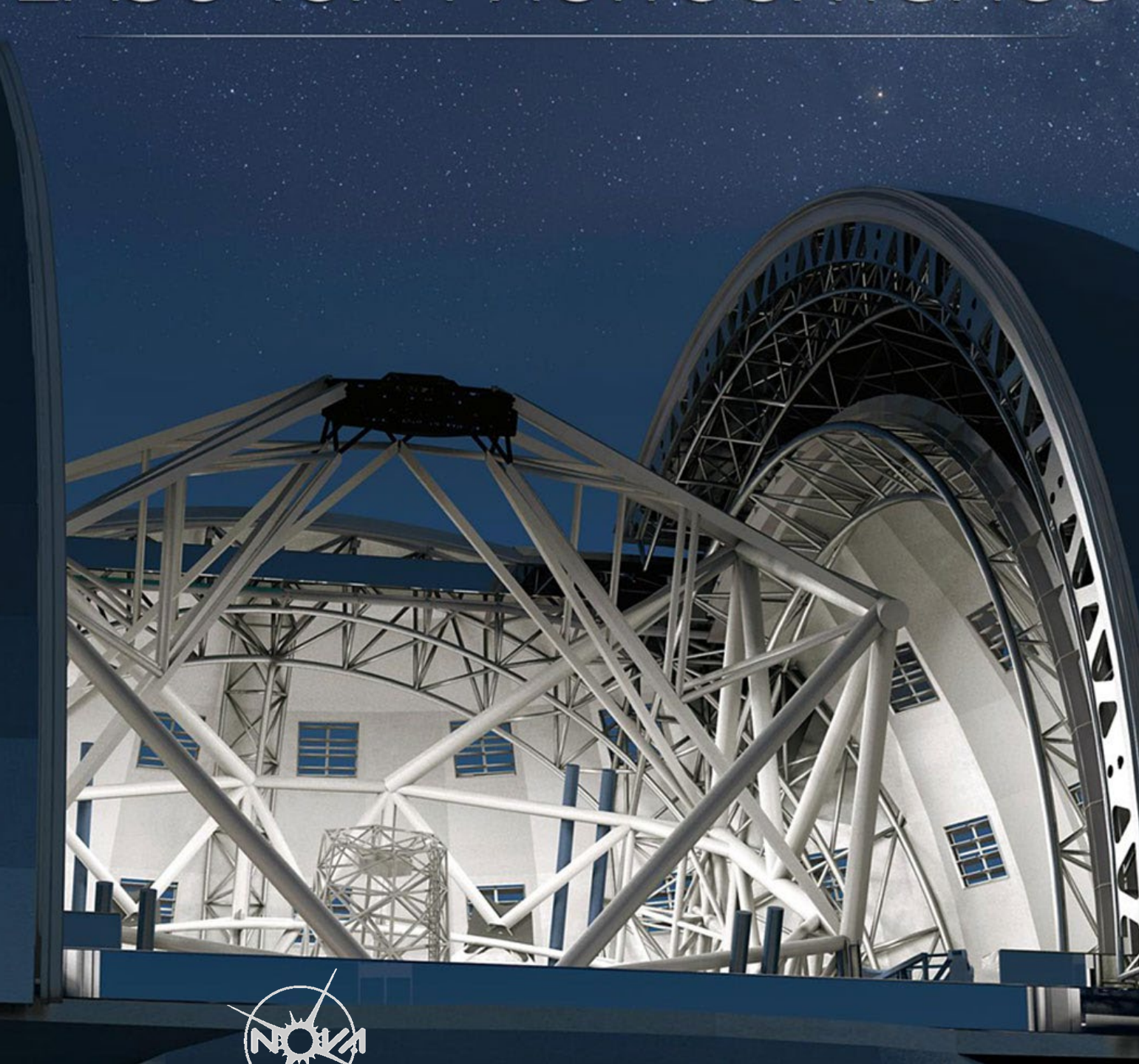

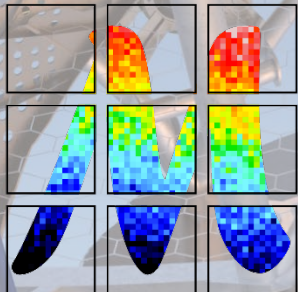

MICADO

METIS

Mid-infrared
ELT Imager and
Spectrograph



Final Design



Construction

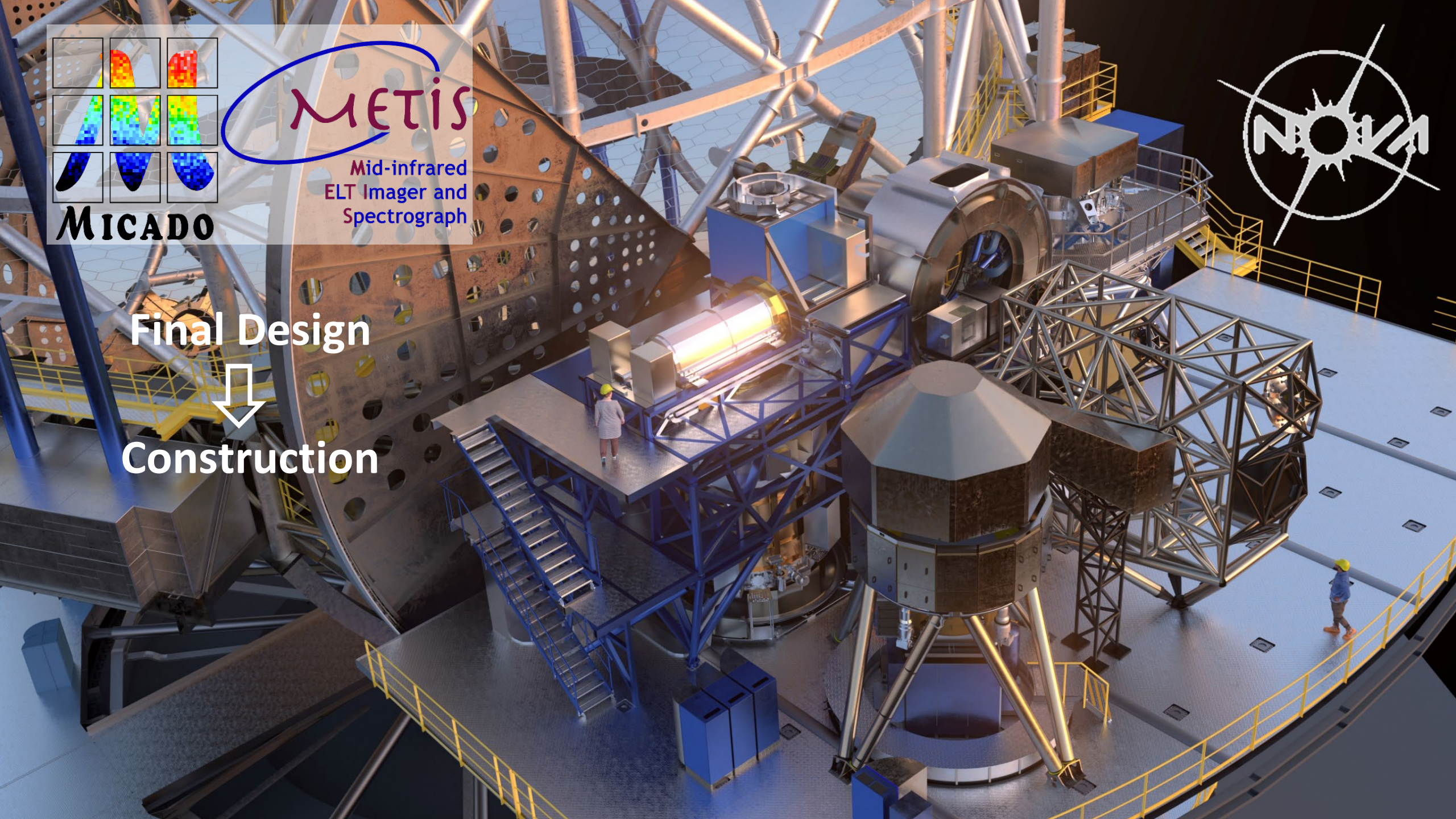

METIS

Mid-infrared
ELT Imager and
Spectrograph

Final Design Review



Construction



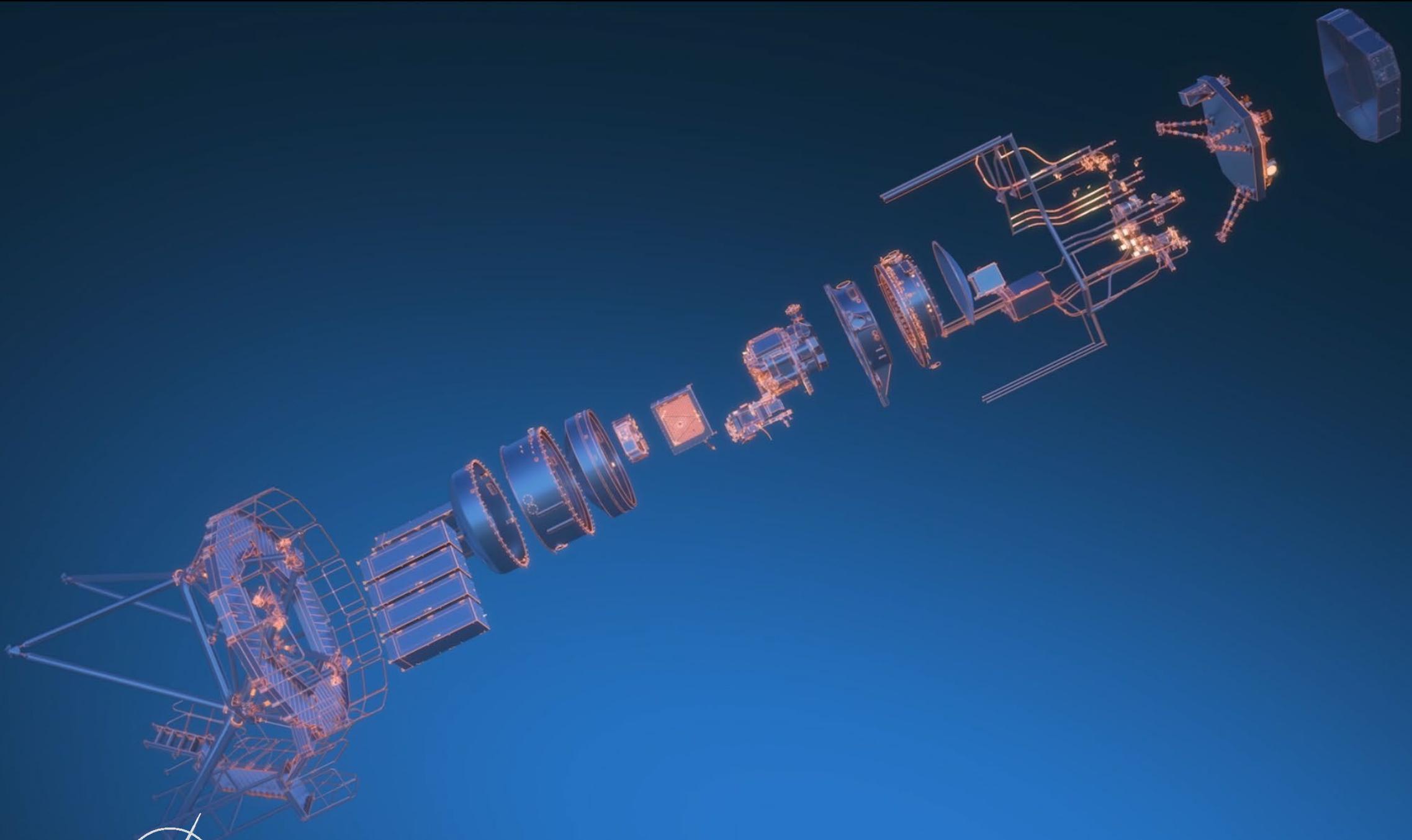

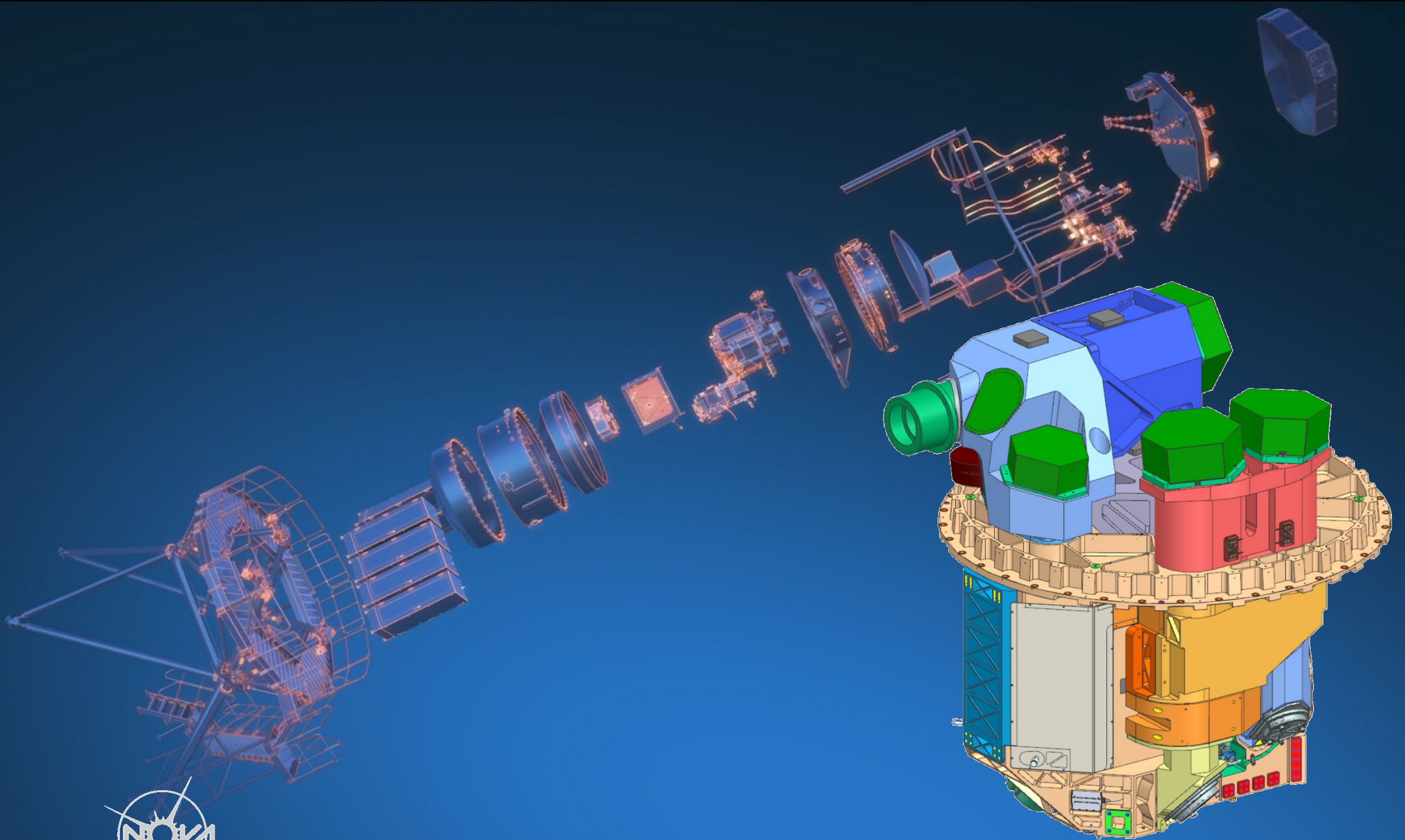



Ø1700 mm

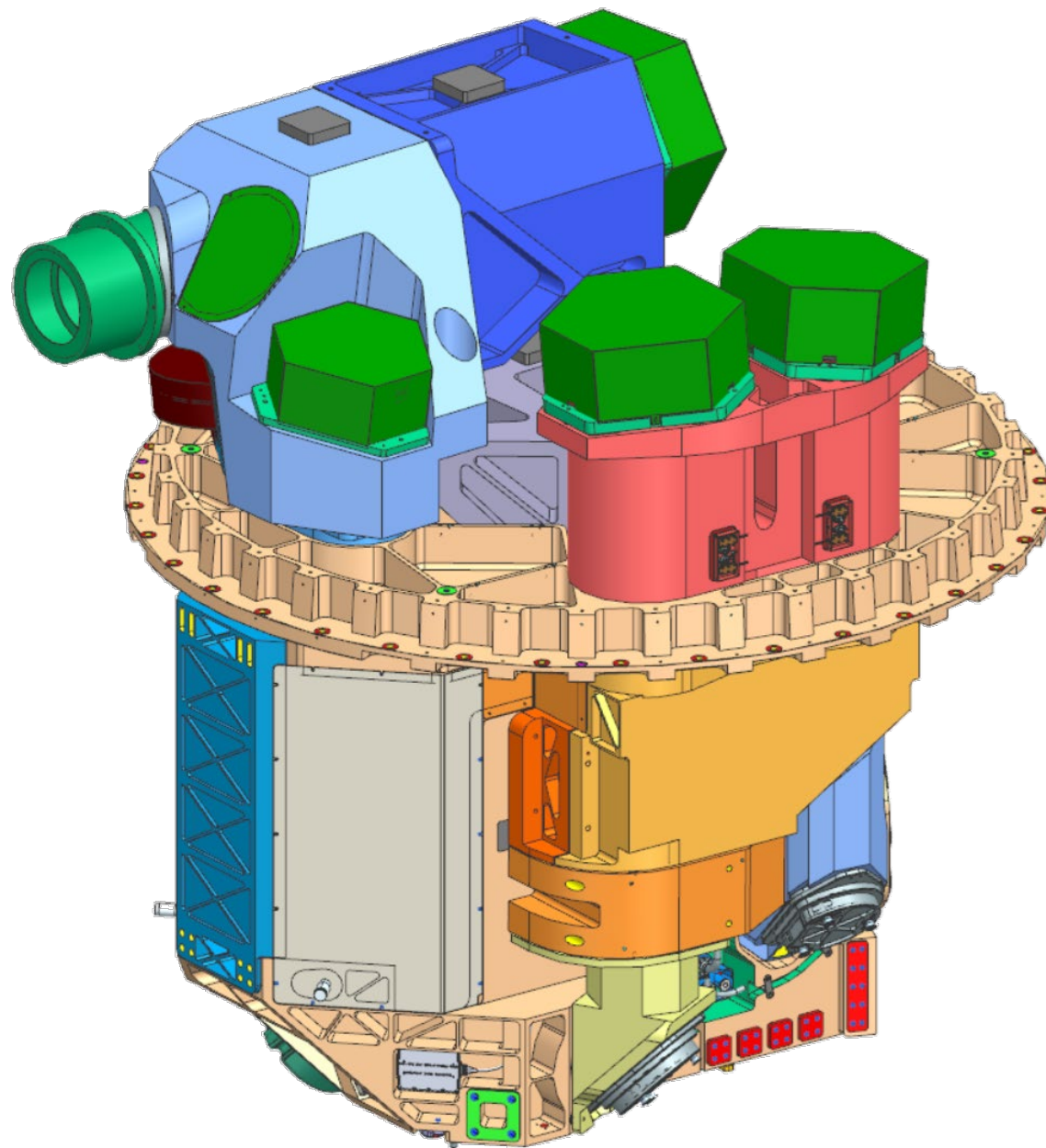

1700 mm

2.300 kg



Ø1700 mm

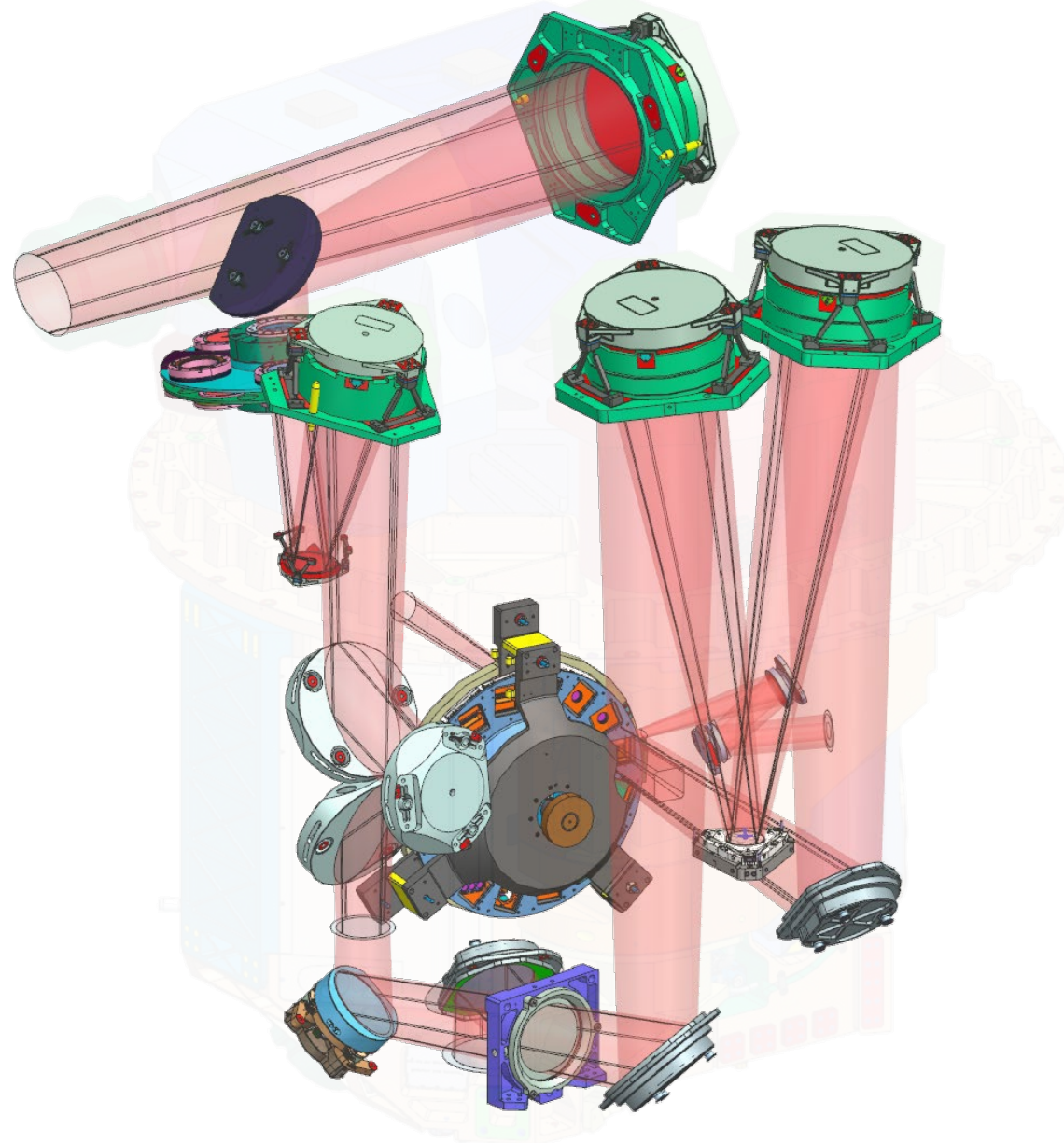

1700 mm

2.300 kg



Manufacturing & Assembly of eXtreme instrumentation

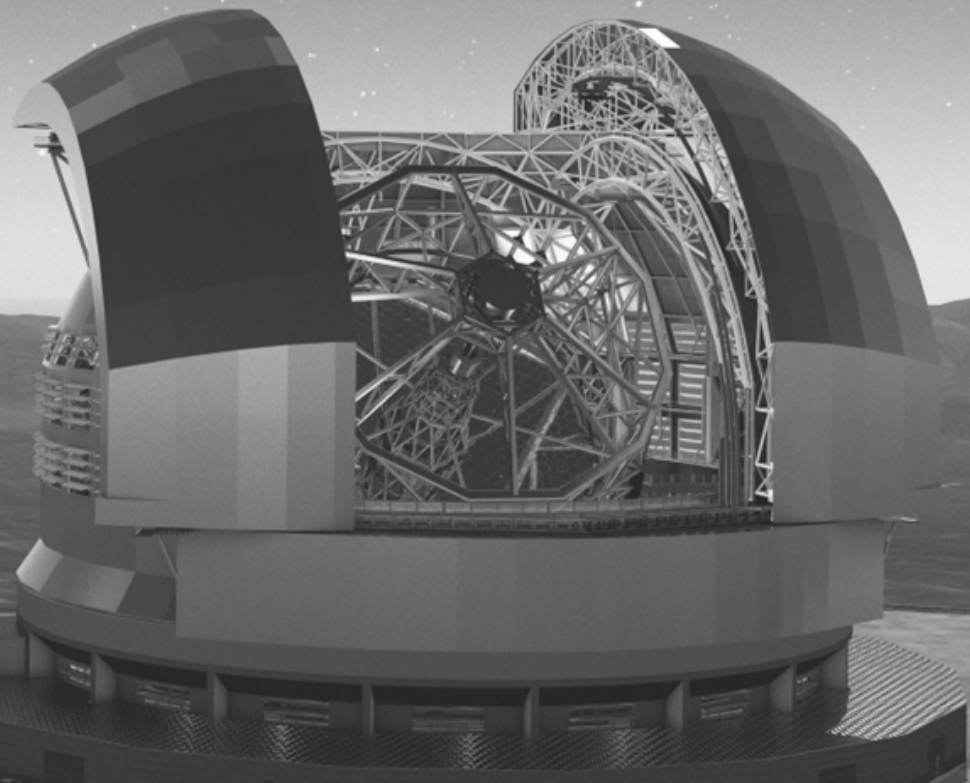



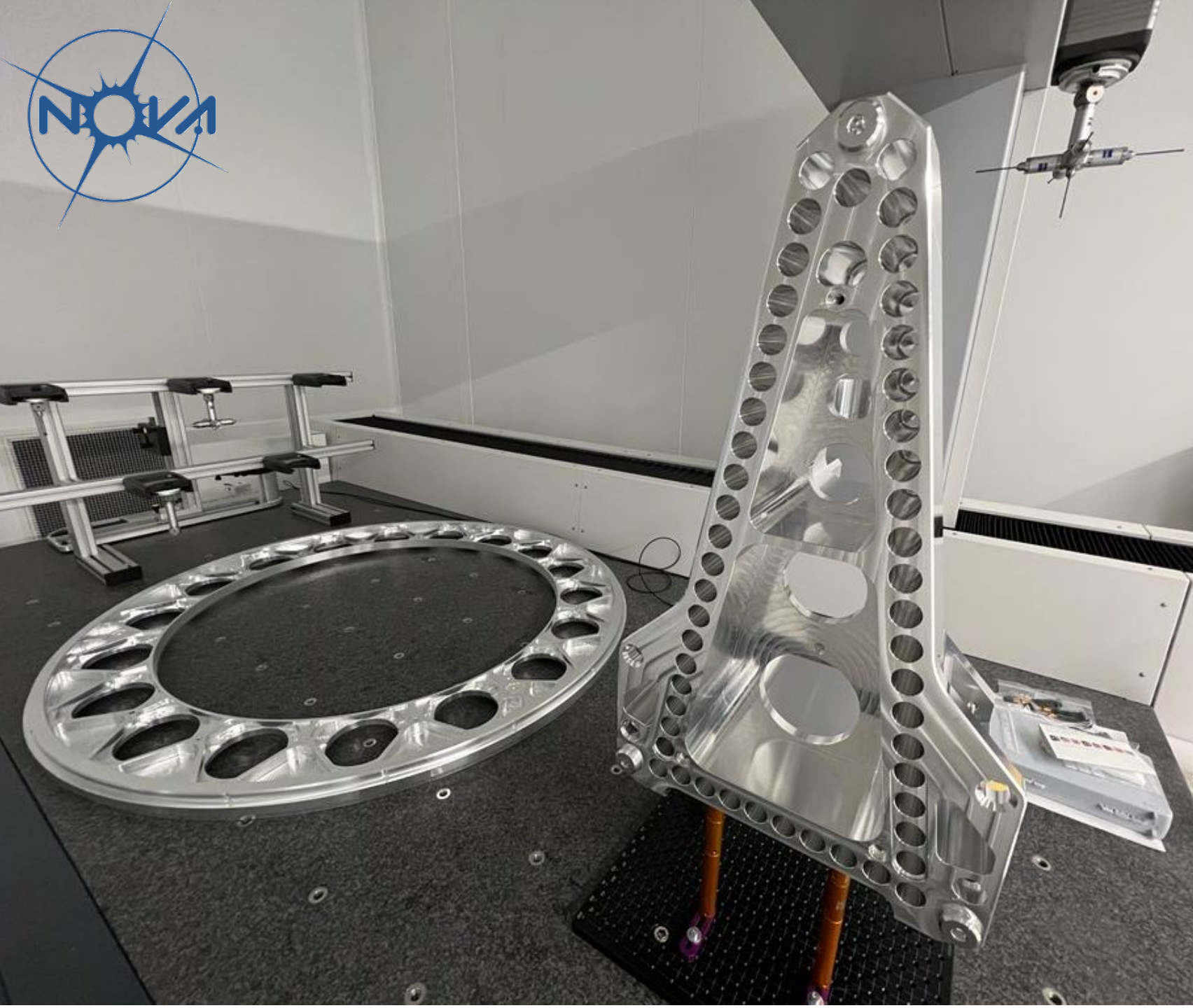



2017 Gravitational Waves

2019 Exoplanet Discovery

2020 Black Holes



The Black Hole Shadow in M 87 Cover Pages, 2019 April 11



Vision & Robotics 2023

Extremely large telescope

